

Berkshire



FREIGHTLINER® XCR CHASSIS WITH TRU-BRACE FOUNDATION

- + Cummins ISB Turbo Diesel 6.7 Liters 360 HP, 800 LB/FT of Torque
- + Allison 3000MH 6-Speed Transmission
- + Trailer Hitch with 10,000 LBS. Capacity
- + V-Ride Rear Suspension 
- + 100 Gallon, Locking Dual Fill Fuel Tank
- + Drivers Side Mounted 13 Gallon DEF Tank



BERKSHIRE FEATURES

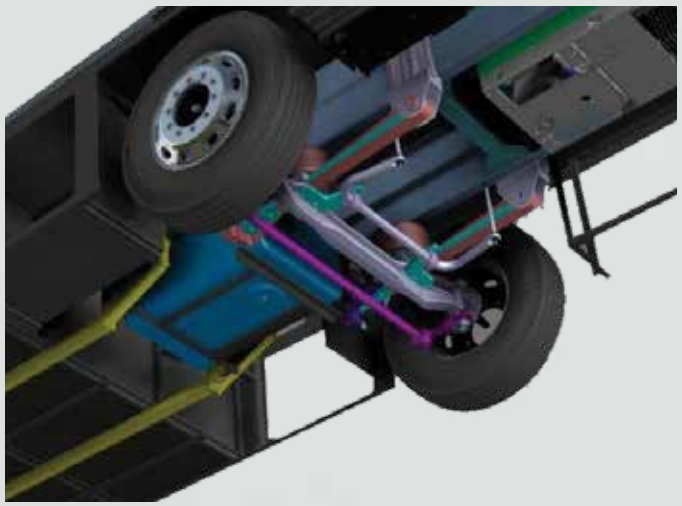

TRU-BRACE
ANTI-CAMBER SUPPORT BRACING



3 1/8" THICK FLOOR
INCREASES RIDE QUALITY, REDUCE ROAD NOISE, ADDED RIGIDITY TO THE FOUNDATION



5 1/4" THICK ROOF
CROWNED ONE PIECE FIBERGLASS ROOF



NOBLE SELECT
PREMIUM COMPOSITE, HIGH GLOSS SIDEWALLS. IMPERVIOUS TO WATER, RESISTANT TO THE ELEMENTS & IMPACT, PUNCTURE RESISTANT.



CUMMINS ONAN GENERATOR
8KW STANDARD ON 34B AND 39A FLOORPLANS (10.0KW ON 40F), WITH SLIDE OUT GENERATOR ACCESS



2000 WATT INVERTER
2000W PURE SINE WAVE INVERTER/CHARGER



WATER MANIFOLD SYSTEM
OFFERING POINT TO POINT CONNECTIONS, EQUALIZED WATER PRESSURE AND TEMPERATURE, AND THE ABILITY TO ISOLATE ANY ISSUE



WATER HEATER
TRUMA AQUA GO TANKLESS WATER HEATER PROVIDES UNLIMITED HOT WATER



SHOWER MISER SYSTEM
EXTENDED STAY TECHNOLOGY HELPS INCREASE FRESH WATER & GRAY WATER TANK CAPACITY WHEN DRY CAMPING



PASSENGER WORK STATION
STOW AWAY PASSENGER SIDE WORK TABLE



WIRELESS PHONE CHARGE
DRIVER CONSOLE INDUCTION CHARGER.



MULTIPLEX CONTROL
PRECISION CIRCUITS MULTIPLEX SYSTEM WITH PRECISION PLEX APP



INDUCTION COOKTOP
FLUSH MOUNTED TO INCREASE COUNTER TOP SPACE, SAFER TO USE

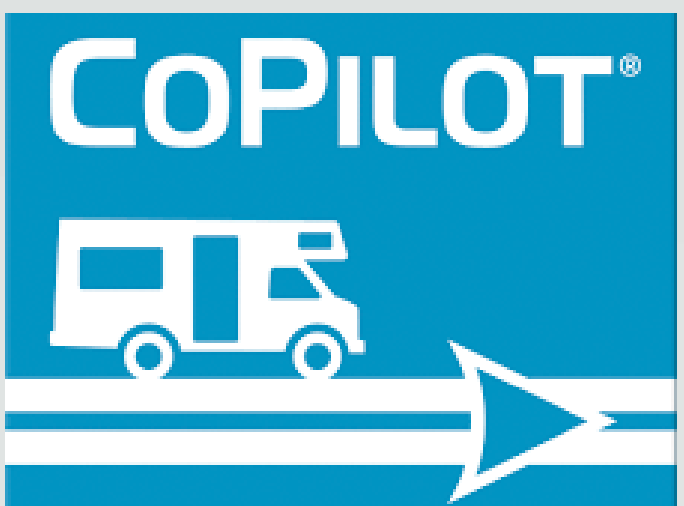

CO-PILOT NAVIGATION
GPS DESIGNED FOR RV'S

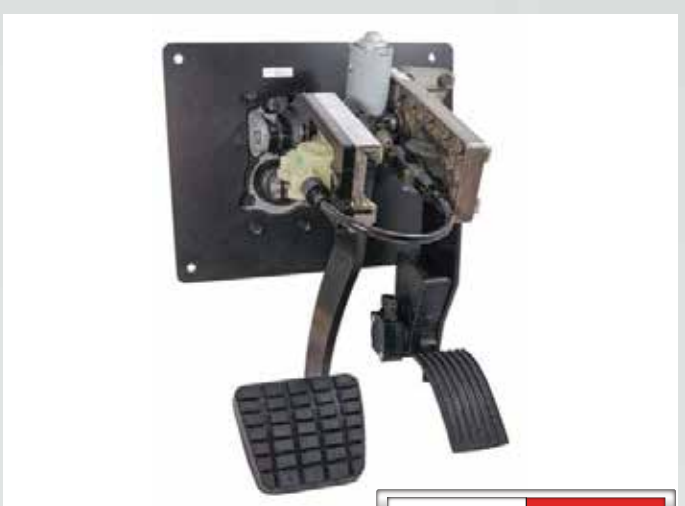

SUSPENDED PEDALS
OFFERS A BETTER VIEW OF THE GAUGES, CONVENIENT ACCESS TO CONTROLS AND A MORE AUTOMOTIVE LOOK

34B

8
Standard 7
Optional 5

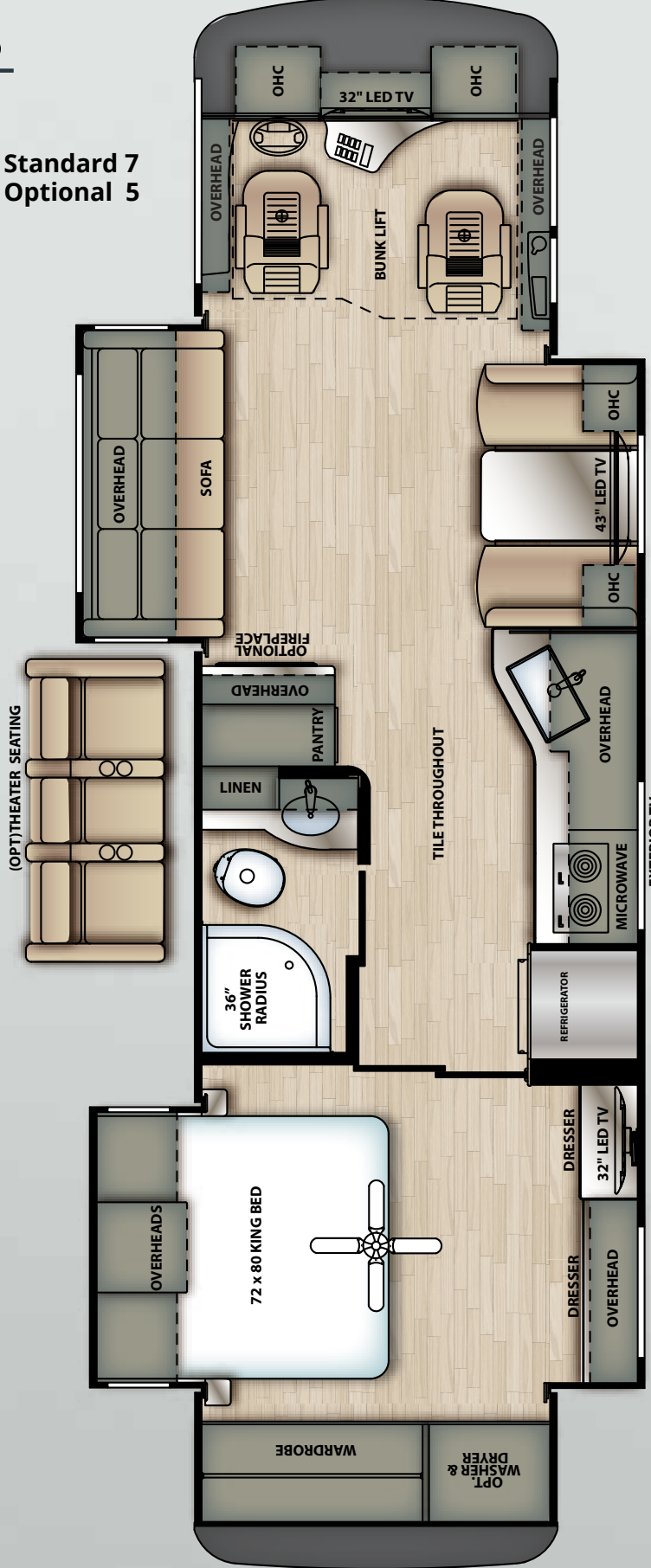

39A

8
Standard 7
Optional 5

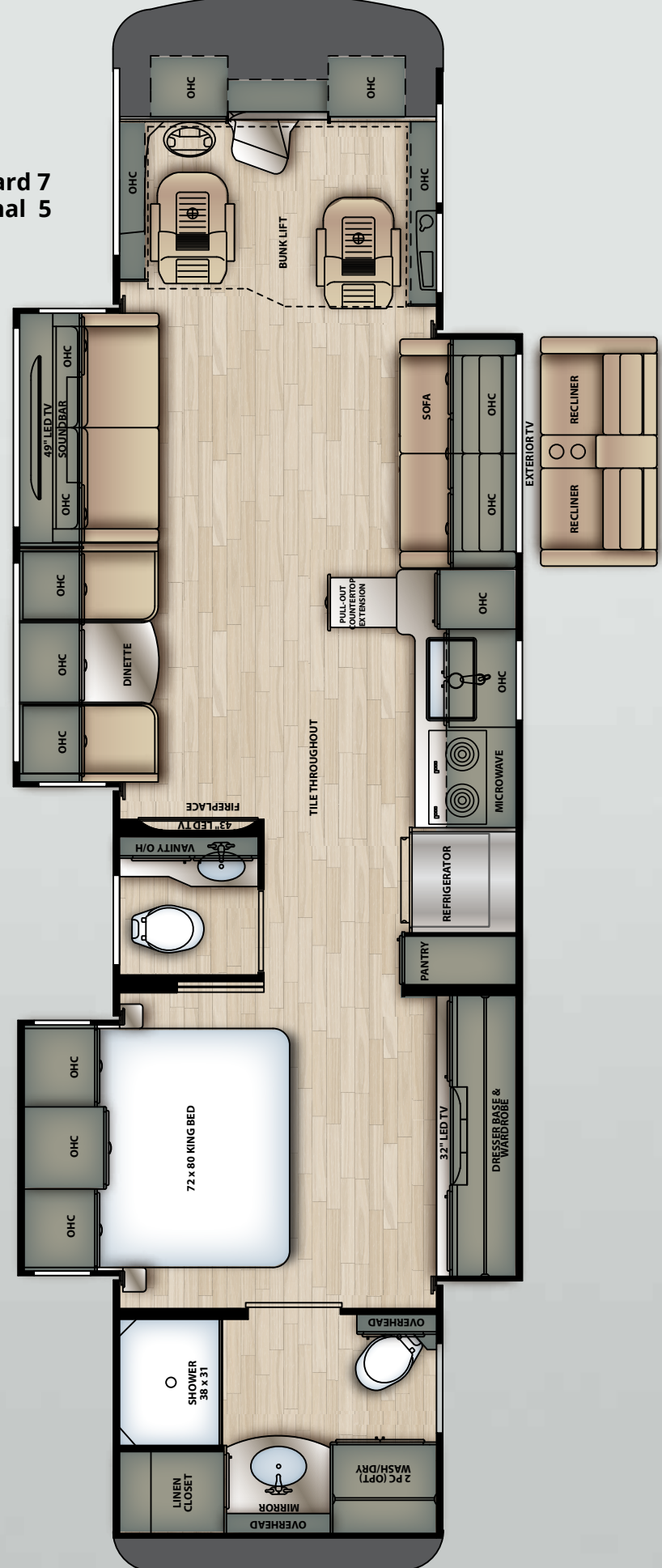

40F

8
Standard 7
Optional 5

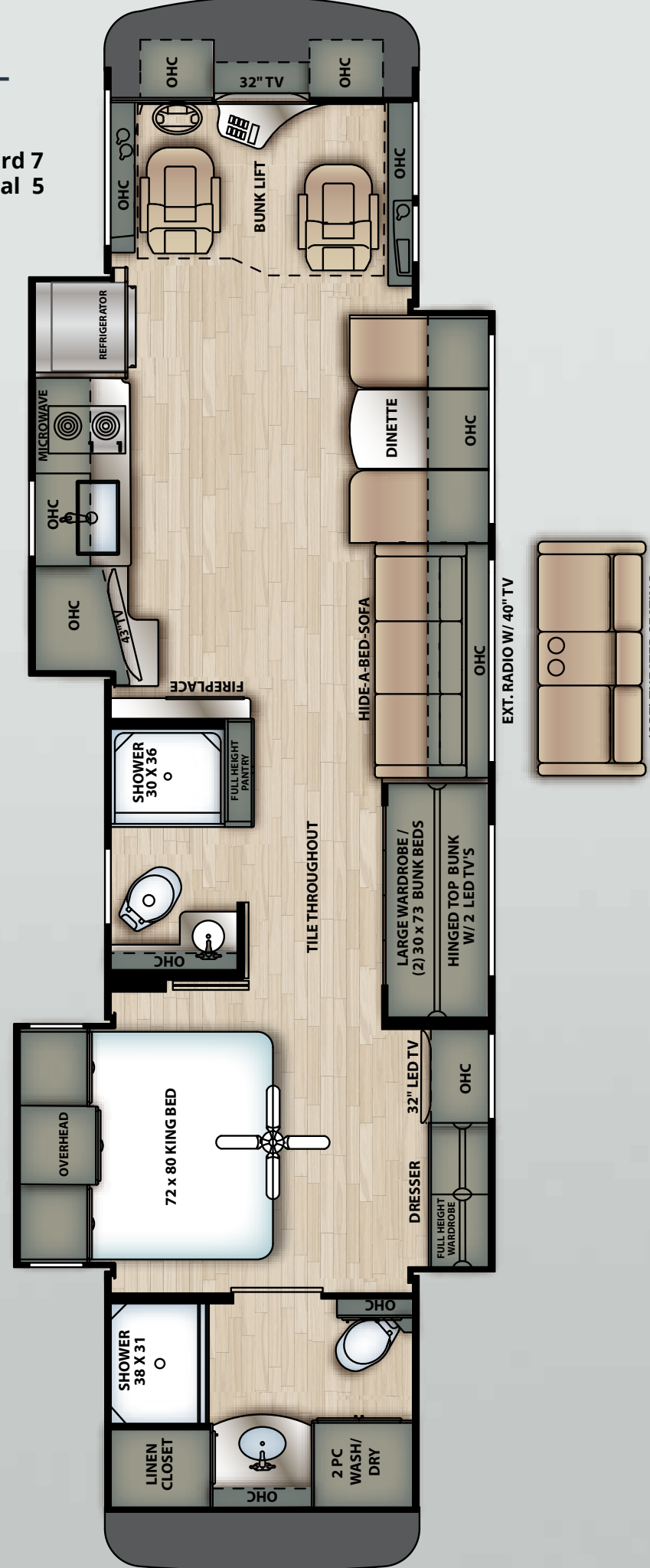

CONVENIENCE STANDARD PACKAGE FEATURES



STANDARD & OPTIONAL FEATURES

- + 2-Door Residential Refrigerator
- + Hardwood Cabinetry Throughout The Coach
- + Power Drop Down Cab Over Bunk, 500 Lbs Capacity
- + BASF Full Body Paint With 4x The Clear Coat
- + Diamond Shield Front Mask Protective Film
- + Central Vacuum System
- + Bedroom Ceiling Fan
- + High Definition Cat5 Matrix Signal Distribution
- + JBL Sound Bar w/Integrated Sub & Bluetooth
- + Soft Touch Vinyl Ceilings
- + Dual 15K Btu Low Profile Air Conditioners with Front Heat Pump, (3) 15K W/Front and Rear HP 40F Only
- + 10" Dash radio w/ color back-up and side view camera pkg with Navigation & Apple CarPlay™
- + Carefree Latitude Dual Pitch Awning With LED Light & Wind Sensor
- + Smart TVs Throughout
- + 30" Wide Entry Way, With True Diesel Motorhome Entry Door
- + Slide Tray In Basement Storage Compartment
- + Variable 4 GPM Water Pump
- + Electric Fireplace In Living Room
- + Heated Holding Tanks
- + Day/Night Roller Shades Throughout The Coach
- + Prewired For Up To 550w Solar Capacity
- + Optional Stackable Washer And Dryer
- + Optional Theater Seating
- + Optional Winegard HD Traveler Satellite System



Scan the QR Code to learn more about Berkshire Motorhomes.

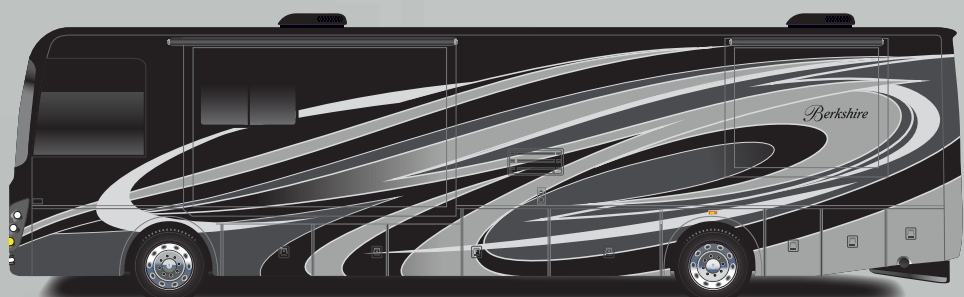

MIDNIGHT SHADOW

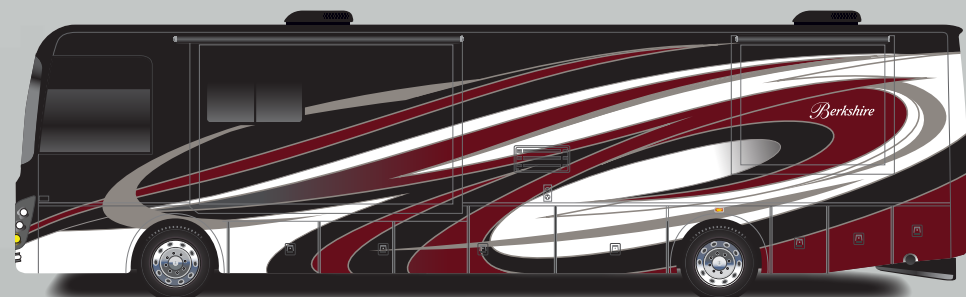

FRENCH COUNTRY

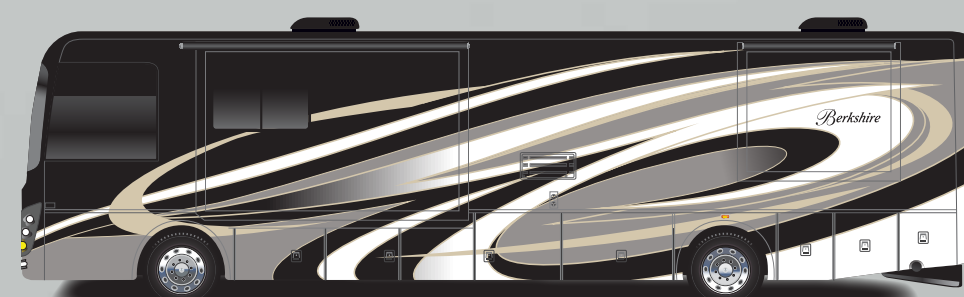

COURTYARD

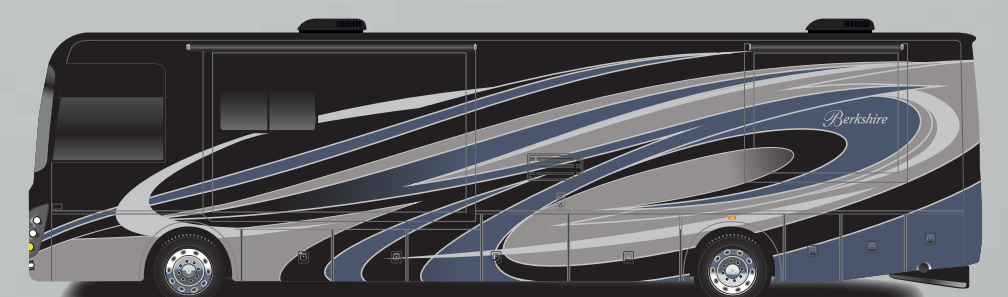

WIND RIDGE